

STM6-LM/STM6 specifications

		STM6-LM		STM6		
				Manual 2-axis	Manual 3-axis	Motorized 3-axis
Microscope body	Focus	Vertical movement range	205mm	155mm		
		Maximum accepted sample height	205mm *1, 150mm *2	155mm *1, 100mm *2		
		Z-axis measurement range	205mm *1, 150mm *2	155mm *1, 100mm *2		
		Coarse focusing speed	4.8mm/s	4.8mm/s		
	Fine focusing speed (variable)	800µm/400µm/200µm/50µm (full rotation of knob) 4 steps	800µm/400µm/200µm/50µm (full rotation of knob) 4 steps			
	Illumination	LED illumination	White: for reflected light illumination, green: for transmitted light illumination Max. power consumption: 10W			
Observation tube		Erect image monocular tube, erect image trinocular tube (100.0/0:100)				
Objective lens	For measuring microscope	MM6-OB series				
	For metallurgical microscope	MPLFLN series, LMPLFLN series, MPLFLN-BD series, LMPLFLN-BD series				
Eyepiece		MM6-OCC10x (with cross hairs, F.N. 22), MM6-OC10x (F.N. 22)				
Stage	Stroke	MM6-CS250 = X-axis: 250mm, Y-axis: 150mm	MM6C-CS50 = X-axis: 50mm, Y-axis: 50mm/MM6C-CS100R = X-axis: 100mm, Y-axis: 50mm MM6C-CS100 = X-axis: 100mm, Y-axis: 100mm/MM6C-CS150 = X-axis: 150mm, Y-axis: 100mm			
	Measuring accuracy	X-axis: (3+5L/250) µm Y-axis: (3+5L/150) µm [L: measuring length (mm)]	50mm stroke: (3+L/50) µm 100mm stroke: (3+2L/100) µm 150mm stroke: (3+3L/150) µm [L: measuring length (mm)]			
Counter display	Minimum readout	0.1µm/0.5µm (selectable)	0.5µm	0.1µm/0.5µm (selectable)		0.1µm
Dimensions *3		684 (W) x 579 (D) x 843 (H) mm	465 (W) x 437 (D) x 596 (H) mm	465 (W) x 437 (D) x 592 (H) mm	465 (W) x 437 (D) x 696 (H) mm	
Weight *4		Approx. 170kg	Approx. 94kg	Approx. 95kg		Approx. 97kg
Power consumption		100-120/220-240V~1.6/0.8A 50/60Hz	100-120/220-240V~0.7/0.4A 50/60Hz		100-120/220-240V~1.6/0.8A 50/60Hz	

*1: With objective lenses for metallurgical microscope

*2: With objective lenses for measuring microscope

*3: STM6-LM microscope body+MM6-CS250 stage combination, STM6 microscope body+MM6C-CS100 stage combination

*4: STM6-LM microscope body+MM6-CS250 stage + integrated unit combination, STM6 microscope body+MM6C-CS100 stage+integrated unit combination

Objective lenses working distance

Objective lenses for measuring microscope	Magnifications	1x	3x	5x	10x	—	
	MM6-OB series		59.6	76.8	65.4	50.5	—
Objective lenses for metallurgical microscope	Magnifications	5x	10x	20x	50x	100x	
	MPLFLN series	Brightfield	20.0	11.0	3.1	1.0	1.0
	LMPLFLN series	Long working distance	22.5	21.0	12.0	10.6	3.4
	MPLFLN-BD series	Brightfield/darkfield	12.0	6.5	3.0	1.0	1.0
	LMPLFLN-BD series	Brightfield/darkfield, long working distance	15.0	10.0	12.0	10.6	3.3

*All brands are trademarks or registered trademarks of their respective owners.

OLYMPUS CORPORATION has obtained ISO9001/ISO14001

Illumination devices for microscope have suggested lifetimes. Periodic inspections are required. Visit our Website for details.

Specifications are subject to change without any obligation on the part of the manufacturer.



OLYMPUS CORPORATION
Shinjuku Monolith, 3-1, Nishi Shinjuku 2-chome, Shinjuku-ku, Tokyo, Japan
OLYMPUS LIFE SCIENCE EUROPA GMBH
Postfach 10 49 08, 20034, Hamburg, Germany
OLYMPUS SURGICAL & INDUSTRIAL AMERICA INC.
One Corporate Drive, Orangeburg, NY 10962, U.S.A.
OLYMPUS AUSTRALIA PTY. LTD.
31 Gibby Road, Mt. Waverley, VIC 3149, Melbourne, Australia.

OLYMPUS LATIN AMERICA, INC.
5301 Blue Lagoon Drive, Suite 290 Miami, FL 33126, U.S.A.

www.olympus.com

Printed in Japan M1655E-0808B

OLYMPUS®

Your Vision, Our Future

MEASURING MICROSCOPE

STM6-LM/STM6

UIS2
World-leading optics



STM6 SERIES

Versatile, high-reliability lineup packed with features to meet every measurement need.

The STM6 series offers more system versatility and higher performance than ever before. Maintaining the exceptional levels of precision and durability that have always characterized Olympus measuring microscopes, the series features a wide range of models to cover various customer's demands for new measuring capabilities and superior functionality. The range includes the STM6-LM, for fast inspection of large samples, and the high-precision STM6 which offers the most compact body in this class. In addition, plentiful optional units ensure that every measurement need can be met. Among the series' outstanding features are motorized focusing, highly advanced UIS2 optics, the high-rigidity body with integrated counters, high-performance long-life LED illumination for bright and clear images, and much more. The STM6 series: built to perform today's most demanding measuring requirements.

STM6 SERIES LINEUP

STM6-LM
Large motorized 3-axis measuring microscope with 0.1µm readout

STM6-LM
Large motorized 3-axis measuring microscope with 0.5µm readout

STM6
Compact motorized 3-axis measuring microscope with 0.1µm readout

STM6
Compact manual 3-axis measuring microscope with 0.1µm readout

STM6
Compact manual 3-axis measuring microscope with 0.5µm readout

STM6
Compact manual 2-axis measuring microscope with 0.5µm readout



Reliability



Technology with traceability — the road to high precision.

Accurate design and leading-edge technology: two keys to significant quality and process improvements.

Rigid body and stage for rock-solid stability over long periods.

STM6 series quality derives from two main sources: time-tested manufacturing expertise plus valuable feedback from numerous customers. Recognizing that precision and rigidity must not only be provided but also maintained for long periods, Olympus achieved exceptional lengths to ensure a high standard of rigidity in the microscope body and stage. Straightness is maintained by utilizing a superb linear guide mechanism. In addition, newly developed Olympus original integrated optical linear scale provides improved reliability.

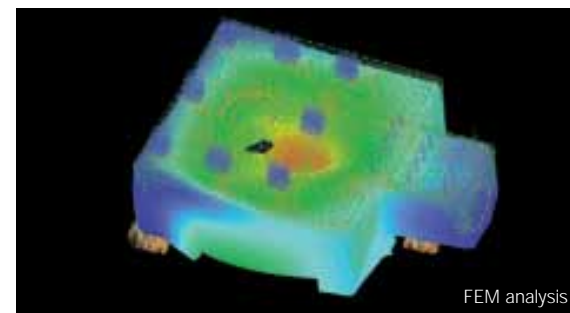

Long-life LED illumination, with little impact on measurement precision.

An LED illuminator is used for reflected/transmitted coaxial illumination. The low-heat character of LED illumination protects specimens from the effects of heat and contributes to more reliable measurement data. In addition, the illuminator has a long operating life, low power consumption, and brightness on a par with halogen. The LED illumination also achieves a dramatic reduction in work interruptions and lamp replacement

maintenance due to lamp burn-out, and this helps not only to reduce operating costs, but also to improve throughput.



Optical linear scale to guarantee sub-micron resolution.

All optical information gained through Olympus' originally developed optical linear scale is processed electrically and measured. The precision of the scale is obviously critical to measuring accuracy — so to minimized error, this scale is mounted to the best position based on the Abbe's theorem, which defines the ideal position of scale and measured object as on the linear line, toward the measuring direction.



Traceability system for higher quality.

Rigorous manufacturing procedures ensure top-class quality control.

Olympus puts the highest priority on precision throughout all the stages of production and assembly. As well as maintaining a strictly controlled thermostatic manufacturing environment, skilled Olympus engineers apply the most rigorous standards to component material selection, high-precision machining, delicate finishing processes and final adjustment. All completed products and component parts are fully controlled under a rigorous traceability system.

Measuring Microscopes Traceability System

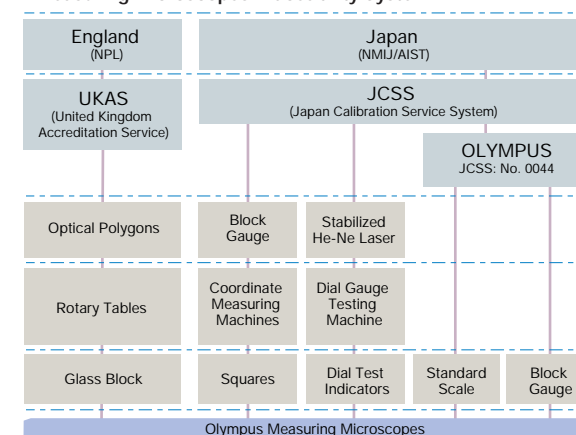

As of October 2006

Height Measurement

The focus system achieves height measurement with superior repeatability — efficiently and with high precision.

Quick and accurate measuring free from operators' dispersion.

Auto Focus System

Simple add-on type auto focus unit.

STM6 series provides two AF modes; the One-shot and Tracking focus. All the height and depth measurements, which require the continuous fine and accurate operation, can be done with utilizing each focusing mode. Z direction measurement efficiencies are dramatically improved with the auto focus so that the operators' dispersion is now minimized. This unit can be easily added on because of its intermediate tube type compact design.

1 One-shot mode

From the roughly focused state, this mode enables instant focus on the center of the field of view.



2 track mode

This mode maintains focus by following the focused surface. Since image is always focused, work efficiency is dramatically improved.

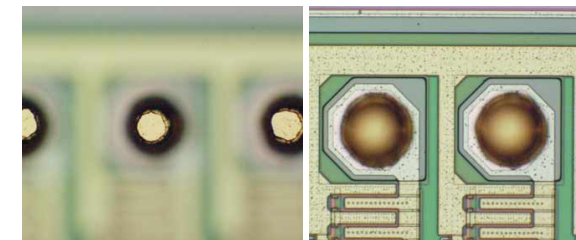

Reproducibility to 1µm using high-magnification objective lenses as well as auto focusing on the extremely small areas.

The confocal auto focus employs active reflection method. This system maintains steady focusing even on samples with angle or unevenness on surfaces. When using 100x objective lenses, the laser spot diameter is 1µm. This allows Z-axis measurement on smaller areas — enabling measurement of, for example, the bonding wires in semiconductor chips.

Objective lens	Reproducibility (2σ ⁿ⁻¹) *1	Spot diameter *2
LMPLFLN20x	2µm	ø5µm
LMPLFLN50x	1µm	ø2µm
LMPLFLN100x	1µm	ø1µm

*1 Values based on our standard samples *2 Theoretical values from calculations

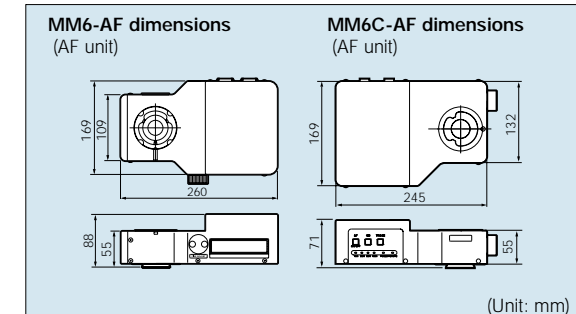

Wavelength λ=785nm, IEC60825-1 Class 1 compatible

Focus Navigation System

Focus navigation system achieves high-precision height measurement simply by focusing the vertical divergence of the index pattern.

This system applies to the reflected light brightfield and darkfield observation using 10x-50x objective lenses. High efficiency height measurement is accomplished by focusing the vertical divergence of the index pattern projected onto the sample. This improves repeatability compared to visual focusing by sample images, and reduces measurement variation due to individual differences between operator. The index pattern is compatible with a variety of samples and can be easily focused, thus greatly reducing measurement time.

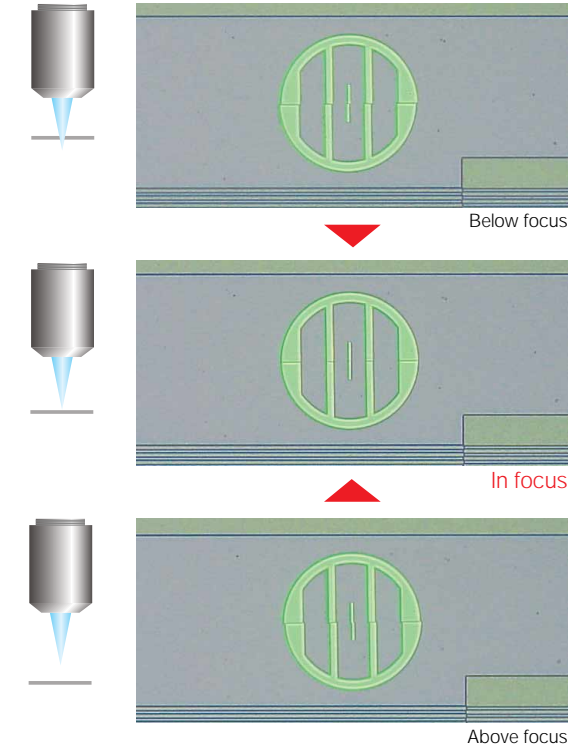

Intermediate tube type that can be added on

An intermediate tube type unit can be easily added on. An LED is used for the light source. The compact control unit enables easy, convenient stepless adjustment of index brightness, and index ON/OFF operation.

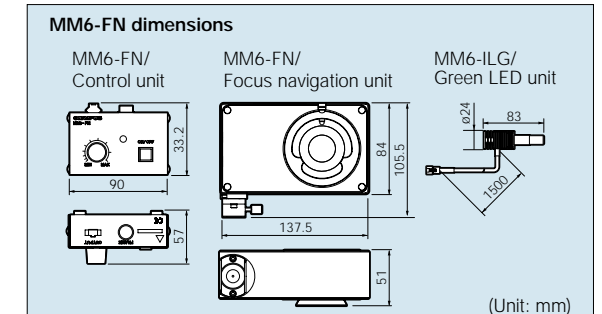

Active reflective type auto focus optical path

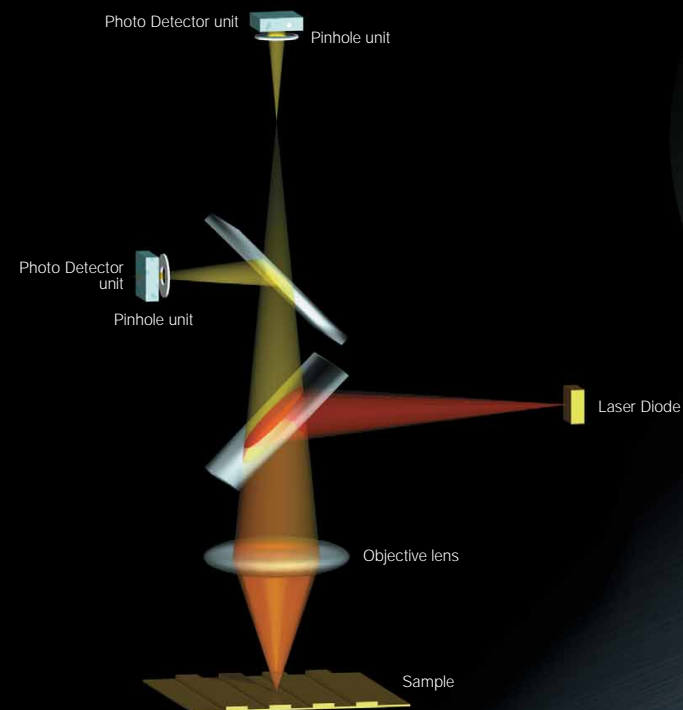

Easy Operation



For Olympus, system expansion and ease of use starts for the sake of operators.

Design ideas to reduce fatigue even in long-time operations.

Motorized focusing for quick and precise Z-axis measurement.

Olympus' introduction of motorized focusing to this category of microscopes drastically improves operability in both focusing and the measuring of height and depth. Exchanges of coarse and 4-step fine movements (800, 400, 200 and 50µm/rotation) are carried out from the Z-axis control box conveniently located right by the operator's hand.

(For STM6-LM and STM6 motorized type)

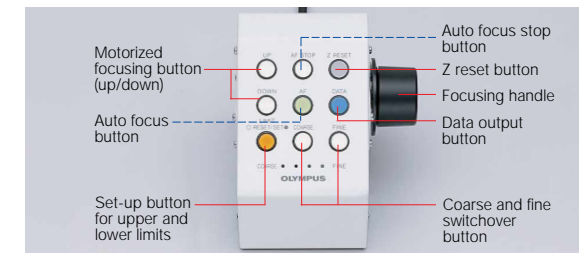

Z-axis operation box

Towards the ideal observation eye-point position: column with counter.

The column with counter is integrated with the microscope body, with the display section comfortably located at almost the same height as the observation eye-point position. The operator can thus confirm the measuring value with only a slight change of eye angle, allowing easier concentration on the sample observation and positioning.



UIS2 optics and LED illumination help further improve edge detection and microscopic inspection.

Edge detection is dramatically improved by using UIS2 optics which achieve outstanding resolution and contrast, and LED illumination which delivers faithful color reproduction unaffected by changes in brightness. This results in greatly improved both measurement and microscopic inspection. LED illumination is also free from the flickering and brightness fluctuation, reducing eye fatigue in long-time use.

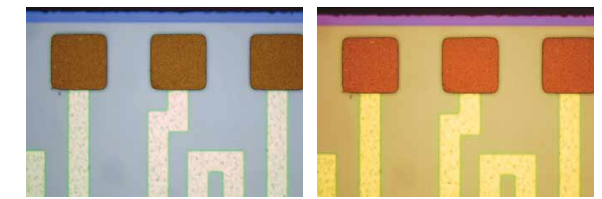

White LED

Halogen lamp

Easy positioning using reticles which correspond to the resolving power of the human eye.

For any measuring microscope, accurate alignment of the measuring object to the reticles is critical. In straight-line alignment, research shows that the use of a reticle and a dotted line produces more accurate results than using only a single line. Through analysis of the characteristics and resolving power of the human eye, Olympus has improved alignment accuracy by using a reticle and a dotted line on the plate.

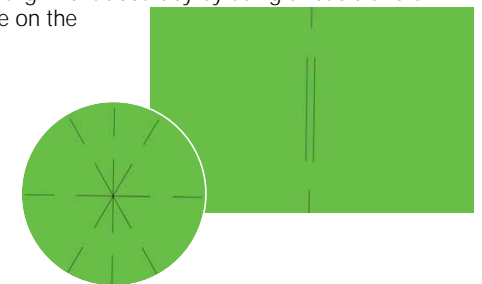

A versatile lineup of add-on units that allow selection of necessary functions and bring dramatic improvements to measurement efficiency.

For high magnification measurement and Nomarski DIC observation.

Three different types of reflected light illumination units are available for both the STM6-LM and STM6, to meet the full range of measurement requirements. Corresponding to measuring objective lenses or metallurgical objective lenses using the revolving nosepiece, these enable brightfield, darkfield and Nomarski DIC observations. The system can be freely upgraded by adding further units according to need.



STM6-LM



- XYZ
0.1µm
- Motorized
- 250 x 150
Stage
- Auto
Focus
Option
- Focus
Navigation
Option

Large motorized 3-axis measuring microscope with 0.1µm readout

MM6-AF AF unit, MM6-VLU universal reflected light illuminator, and MM6-CAL22 2-dimensional data processing unit configuration example



- XYZ
0.5µm
- Motorized
- 250 x 150
Stage
- Auto
Focus
Option
- Focus
Navigation
Option

Large motorized 3-axis measuring microscope with 0.5µm readout

MM6-VL reflected light illuminator for objectives for measuring microscope configuration example

Motorized focusing as standard, for fast, high-precision measurement of large samples.

Motorized focusing dramatically reduces fatigue in Z-axis measurement.

Motorized focusing is equipped as a standard feature. Since the Z control box, which is positioned by the operator's hand, provides easy focusing, it is no longer necessary to take uncomfortable positions to control the Z-axis.

Space efficient body with integrated electric circuits.

The counter column and electric circuits are integrated with the microscope body to save space and facilitate operation. Data can be transmitted via the built-in RS232C, which enables easy connection to external equipment like a personal computer or printer. Data in a personal computer can then easily be used to make a database using such software as Microsoft Excel.



Clutch-type large stage allows quick inspection of large areas.

The stage provides a large measuring area (250x150 mm). All X and Y movements are clutch-controlled, and quick changeover between coarse and fine movements is performed by simply moving a lever. Free movements on the X/Y axis and XY plane allow even large samples to be quickly and accurately inspected. It is also possible to measure multiple samples on the stage at the same time.



STM6-LM dimensions

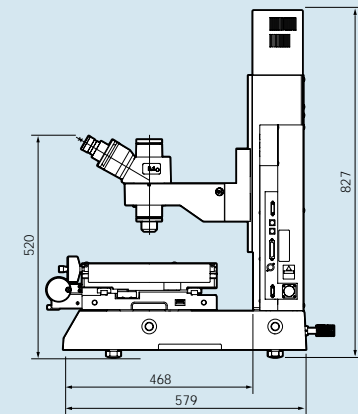
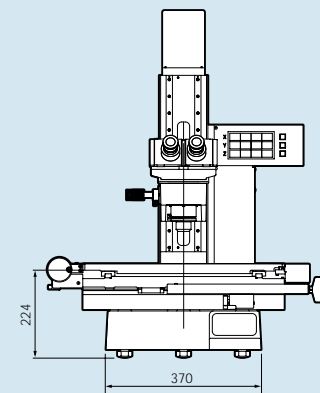

(Unit: mm)

MM6-CS250 dimensions

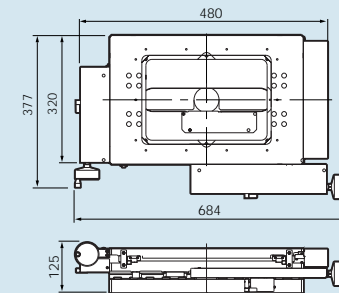

Setting example

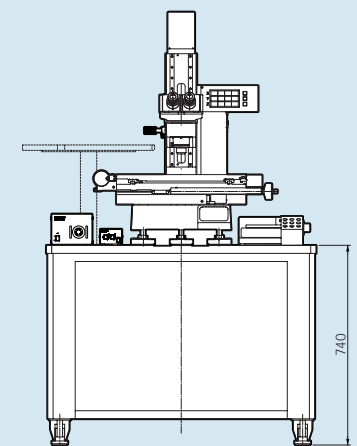
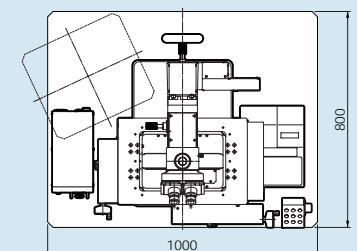

STM6

Compact and highly functional design, with various combinations of bodies and stages.



- XYZ 0.1µm
- Motorized
- 50 x 50 Stage
- 100 x 50 Stage
- 100 x 100 Stage
- 150 x 100 Stage
- Auto Focus Option
- Focus Navigation Option

Compact motorized 3-axis measuring microscope with 0.1µm readout

MM6C-RLAS universal illuminator and MM6C-AF AF unit configuration example



- XYZ 0.1µm
- 50 x 50 Stage
- 100 x 50 Stage
- 100 x 100 Stage
- 150 x 100 Stage
- Focus Navigation Option

Compact manual 3-axis measuring microscope with 0.1µm readout

MM6C-RLAS universal illuminator configuration example



- XYZ 0.5µm
- 50 x 50 Stage
- 100 x 50 Stage
- 100 x 100 Stage
- 150 x 100 Stage
- Focus Navigation Option

Compact manual 3-axis measuring microscope with 0.5µm readout

MM6C-KMAS reflected light illuminator for brightfield/DIC observation configuration example



- XY 0.5µm
- 50 x 50 Stage
- 100 x 50 Stage
- 100 x 100 Stage
- 150 x 100 Stage
- Focus Navigation Option

Compact manual 2-axis measuring microscope with 0.5µm readout

MM6C-VL reflected light illuminator for objectives for measuring microscope configuration example

Space-saving body allows installation to a convenient place.

This model is the smallest in size in this class of measuring microscope despite of its numerous versatile functions.

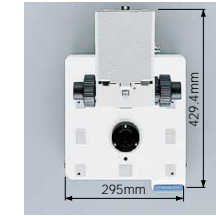

4-model lineup to perform a full range of different jobs.

One motorized 3-axis model with 0.1µm readout, two manual 3-axis models with 0.1µm and 0.5µm readouts and one manual 2-axis model with 0.5µm readout give users a wide variety of selection to suit their specific purpose.

Compatibility of high magnification requirements and wide measuring areas.

The best combination can be selected from four types of stage and a variety of reflected light illumination systems. Three of the stage types (50x50, 100x50 and 100x100) are equipped with coaxial knobs for coarse and fine movement, while the fourth (150x100) has a clutch-free mechanism to enable quick movement and precise positioning.

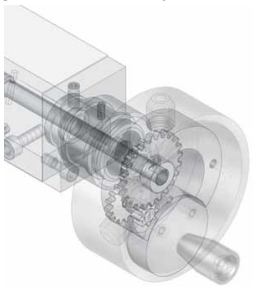

STM6 (Motorized model) dimensions

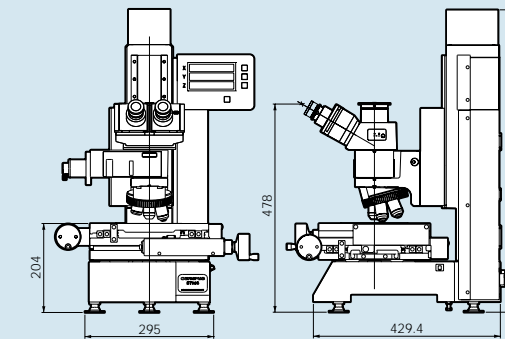

STM6 (Manual model) dimensions

(Unit: mm)

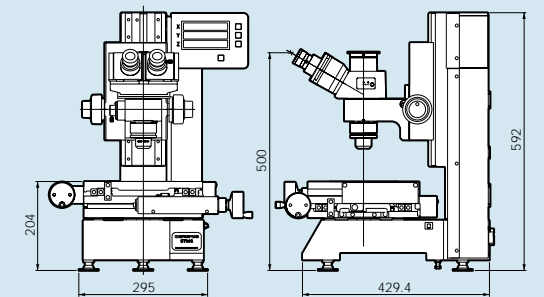

MM6C-CS50 dimensions 50x50 stage

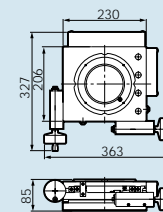

MM6C-CS100R dimensions 100x50 stage

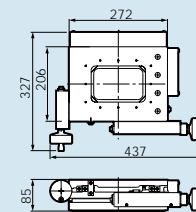

MM6C-CS100 dimensions 100x100 stage

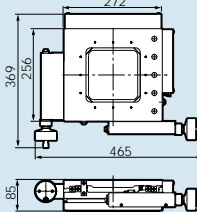

MM6C-CS150 dimensions 150x100 stage

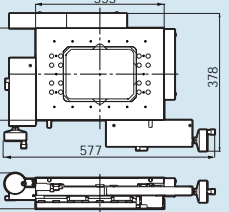

Setting example: 150x100 stage configuration

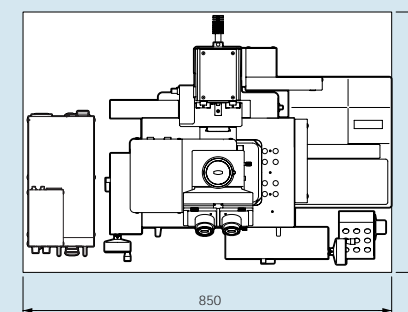

Setting example: 50x50 stage, 100x50 stage or 100x100 stage configuration

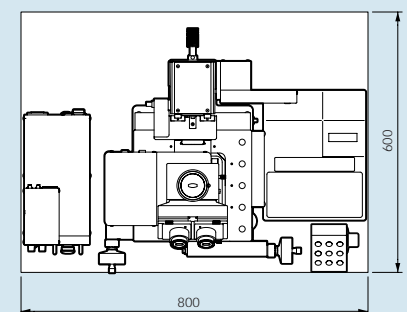

MM6-CAL22



Improve throughput without parallel alignment.

Since parallel alignment of a sample with the stage travel is unnecessary, the operator can start measuring immediately after the sample is placed on the stage.

Calculate and output the result with point data input.

Two dimensional measuring calculation is performed speedily by simple point data input. During measurement, an explanation of alignment and measuring items are shown on the display. Measurement results are output from the built-in printer.

Hot-key assignment for alignment and measuring items.

Now the necessary function can be assigned to the buttons without increasing number of keys. It realizes the easy and user-friendly operation with maintaining its compactness.

RS232C interface as standard.

Stored measurement data can be transferred to a personal computer via the standard RS232C interface, and organized with commonly used software.

Easy-to-understand icon-based operation panel.

Alignment items, measuring items and input items can be selected easily using icons which can be understood at a glance. For all items, multi-point designation calculation enables to increase accuracy of measurements. Up to 8 different patterns of teaching procedures can be saved with combination of various kinds of measuring function.

Display of measurement results and printer output.





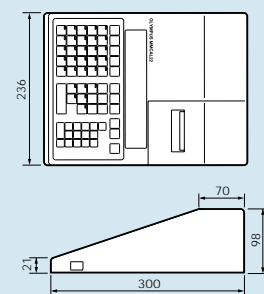





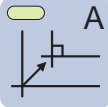
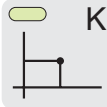
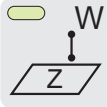
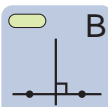

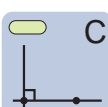
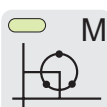
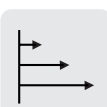
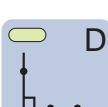

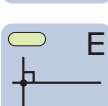
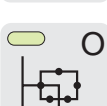

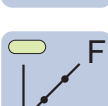
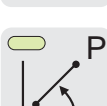

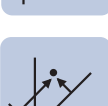
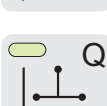
During program measurement, the running situation is shown on the display. Statistical values for measurement results and the results of their determinations against the tolerance can be displayed on the display or printed using the built-in printer.

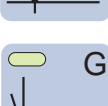
MM6-CAL22 dimensions

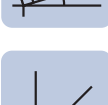
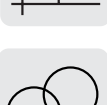

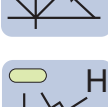
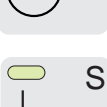
(Unit: mm)

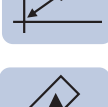
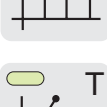
Versatile calculation functions in a compact data processor.

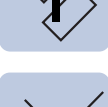
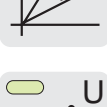
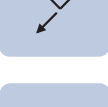
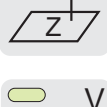
Alignment		A Parallel X/Y shift Input point "1" will be the new original position with shifting the X/Y coordinates position.	Measuring and calculating items		K Direct coordinates Measures the coordinate of input point 1.	Data input methods		W Two points for distance Calculate the distance between two input points at different height.
		B Two points for X and center The line through input points 1 and 2 becomes the X-axis and the midpoint becomes the origin.			L Midpoint coordinates Calculate the coordinate of the midpoint between input points 1 and 2.			4 Four points for perpendicular distance Calculate the perpendicular distance from input point 4 and after to a plane determined by point 1 through 3.
		C Two points for X and origin The line through input points 1 and 2 becomes the X-axis and input point 1 becomes the origin.			M Three points for circle measurement Calculate the diameter, radius, and center coordinates of a circle determined by the input three points.			5 Distance from reference line and previous point Determine a line with point 1 and 2 then measure the distance from point 3 to the line. Measure distance to the line and to the previous point from the 4th and after point.
		D Three points for X and Y The line through input points 1 and 2 becomes the X-axis, and the perpendicular line from input point 3 down to the X-axis becomes the Y-axis.			N Four points for coordinates and angle Calculate the intersection coordinates and intersection angle of two lines determined by point 1 and 2, and point 3 and 4.			6 Parallelism measurement Calculate crossing angle of two lines that are determined with point 1 and 2, and point 3 and 4. Also calculate length of perpendicular line from the line determined with point 3 and 4 to the other at the typed in reference position on the line determined with point 1 and 2.
		E Three points for X and Y Input point 3 becomes the origin and the line parallel to the line through point 1 and 2 will be X-axis.			O Five points for rectangle Calculate each side of a rectangle that passes point 1 through 5, and its center coordinates.			7 Perpendicularity measurement Calculate shift of crossing angle of two lines that are determined with point 1 and 2, and point 3 and 4 (Obtaining crossing angle is calculated as the difference angle from the reference angle of 90°).
		F Four points for X and origin The line through input points 1 and 2 becomes the X-axis. The intersection of the X-axis and the line through input points 3 and 4 becomes the origin.			P Two points for angle, distance and coordinates Calculate angle of a line through points 1 and 2 to the X-axis, the distance between the 2 points, and the coordinate differences of the X-and Y-axes.			8 Flatness of plane Calculate the difference between highest and lowest value (flatness) among any input points on the same plane.
		1 One point to rotate coordinates Input 1 and use numeric keypad to input either X-axis value and Y-axis value signs or X-axis value signs and Y-axis value signs. Rotate the coordinate system so that input point 1 becomes the set up axis value sign.			Q Three points for perpendicular distance Calculate the perpendicular distance from point 3 to the line through points 1 and 2.			9 1 point input Used when directly input a point as data. Measured data is processed as input data.
		2 One point to rotate for X-axis Without shifting the origin point, rotate the coordinate system so that input point 1 lies on the X-axis.			R Five points for radius and coordinates Calculate the intersection coordinates created by a circle that passes point 1 through 3, and a line determined with points 4 and 5 as well as the radius of the circle.			0 2-point input Used when the input point is midpoint of two measured points. This midpoint coordinate is processed as input data.
		3 Angle for rotation Rotate the coordinate system by the entered angle A.			6 Six points for intersection coordinates and radius Calculate intersection coordinates created by a circle that passes point 1 through 3, and a circle that passes point 4 through 6. Also measures the radius of each circle.			1 3-point input Used when input point is the center of a circle. The center coordinates of the circle created by three measured points is processed as input data.
		H Previous coordinates Go back to the previous coordinates setting.			S Coordinates, differences and distance Calculate X-Y coordinates at the input point, as well as differences of X-Y coordinates and distances the previous input points.			2 4-point input Used when input point is the intersection of two lines. The intersection coordinates value created by two lines from 4 input points is processed as input data.
	4 One point for Z parallel move Shift the Z-axis in parallel so that the origin point lies in the plane of input point 1.		T Distance from origin and angular difference Calculate distance between input point and original point; the angle from the X-axis; and the angle difference from the previous input point.		3 5-point input Used when input point is the center of the rectangle. Two input points form one side of rectangle and the other three points for other three sides of rectangle. This center coordinates is processed as input point data.			
	5 Boot-up coordinates Go back to the boot-up coordinates setting.		U One point for Z distance Calculate the Z-axis distance of input point 1 from the reference plane.					
	6 Coordinates for origin Input X and Y points via the numeric keypad as the new origin so that the coordinates moves in parallel to the new origin.		V Z distance Measure Z coordinate of input point plane and Z distance from previously input point's plane.					

■ DP20/Microscope digital camera

Live images at 15 frames/second are displayed in high definition television class resolution so that focusing on the monitor is performed easily without any breaks in traveling the stage during observation and faithful color is obtained at a high resolving power. The DP20's high-speed image capture function (up to 4 high-quality, uncompressed image shots with 1-second intervals) allows the images to be captured continuously, while the inspection proceeds without interruption. Also, the DP20 enables image recording and simple measurements without a PC.



■ MM6-RHS250, MM6C-RHS100/Reset switch

The switch to reset X and Y counter values is near the operator's hand.



■ MM6-RK01/Remote key unit

X, Y and Z counter reset, data output and one-half count exchange are fully controlled from close to the operator's hand.



■ MMFS01/Foot switch

Enables hands-free transmission of data to a printer or 2-dimensional data processing unit.



■ MM6-EMO/Erect image monocular tube

Monocular tube for erect images. Can be used in combination with MM6-OCC10x (eyepiece with cross hairs).



■ SZ-LW61/White LED illumination unit

This light-weight, space-saving design model provides a long operating life and low power consumption. The cost-effective LED illumination unit is also free from the flickering and brightness fluctuation.



■ SZX2-ILR66+SZX-RHS/LED ring illuminator+manual control unit

SZX-RHS manual control unit enables independent illumination of 4-segments of the SZX2-ILR66 reflected LED ring illuminator which provides clear images with high color temperature. The optimal illumination can be selected from 13 patterns.

■ Stage

Several kinds of stages are available to suit different sample sizes.



MM6-CS250 250x150 stage



MM6C-CS150 150x100 stage



MM6C-CS100 100x100 stage



MM6C-CS100R 100x50 stage



MM6C-CS50 50x50 stage

■ Rotatable table

Enables easy parallel alignment of sample.



MM6-RS3 rotatable stage, type 3 (For MM6-CS250)



MM6C-RS2 rotatable stage, type 2 (For MM6C-CS150)



MM6C-RS1 rotatable stage, type 1 (For MM6C-CS100R and MM6C-CS100)

System Diagram

STM6-LM

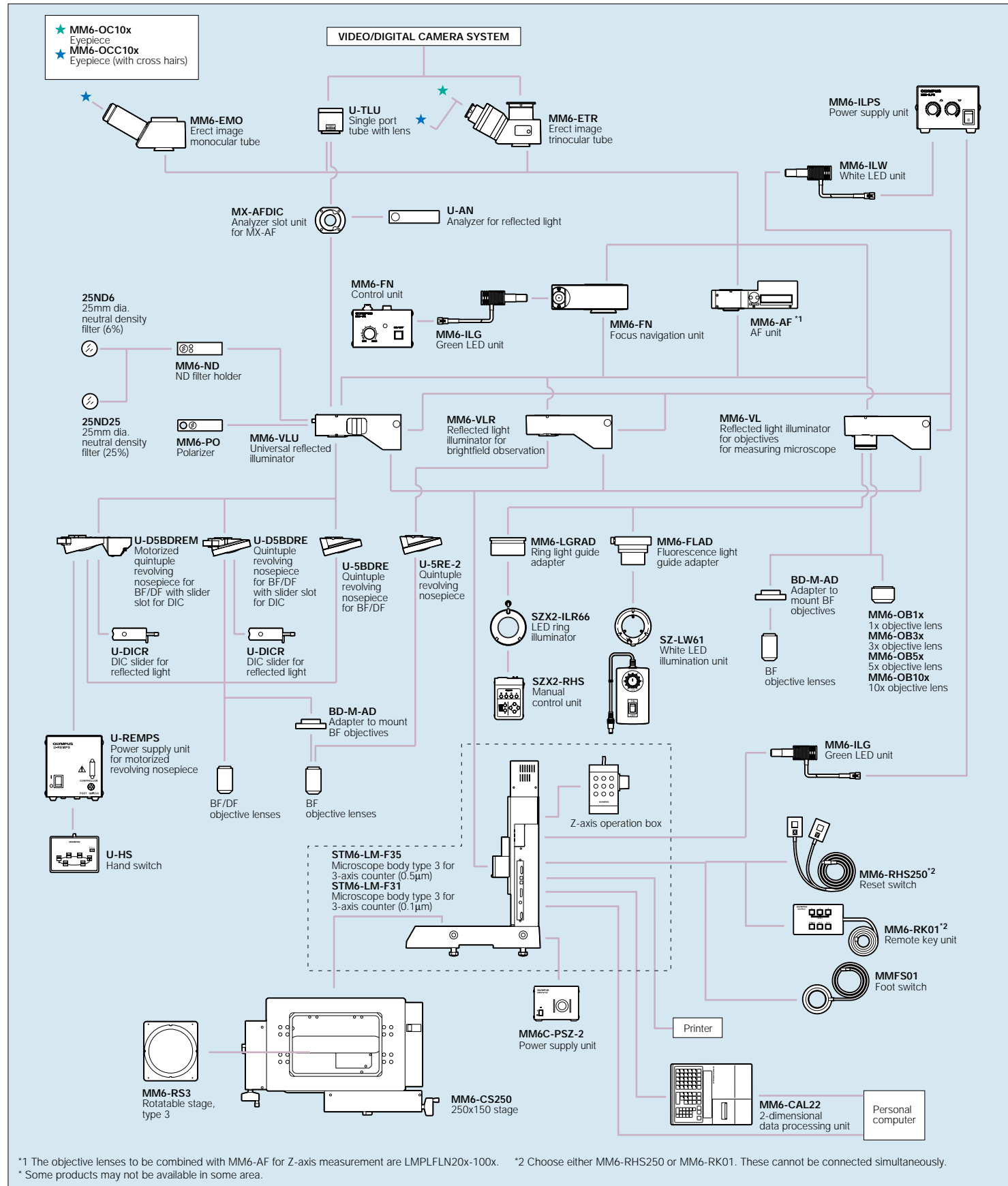

STM6

